

FIITJEE

NTSE STAGE II
CODE: 13 – 15 (2019 – 2020)
SCHOLASTIC APTITUDE TEST
Held on: February 14, 2021

HINTS & SOLUTIONS

BIOLOGY

1.	4	2.	4	3.	3	4.	2
5.	4	6.	4	7.	1	8.	3
9.	1	10.	1	11.	2	12.	1
13.	2						

CHEMISTRY

14.	4	15.	3	16.	1	17.	2
18.	1	19.	1	20.	2	21.	2
22.	1	23.	4	24.	4	25.	1
26.	3						

PHYSICS

27.	4	28.	4	29.	3	30.	3
31.	2	32.	3	33.	3	34.	1
35.	2	36.	1	37.	4	38.	3
39.	4	40.	2				

MATHEMATICS

41.	3	42.	1	43.	4	44.	1
45.	3	46.	2	47.	2	48.	3
49.	2	50.	2	51.	4	52.	2
53.	4	54.	No Option Correct			55.	2
56.	1	57.	1	58.	1	59.	2
60.	4						

SOCIAL SCIENCE

61.	3	62.	1	63.	2	64.	4
65.	2	66.	1	67.	1	68.	2
69.	1	70.	1	71.	4	72.	3
73.	3	74.	1	75.	3	76.	2
77.	3	78.	4	79.	3	80.	1
81.	2	82.	4	83.	1	84.	3
85.	1	86.	3	87.	2	88.	4
89.	2	90.	4	91.	4	92.	2
93.	1	94.	4	95.	2	96.	4
97.	2	98.	3	99.	1	100.	2

BIOLOGY

1. 4

Sol. Specimen belongs to echinodermata phylum.

2. 4

Sol. $AaBbCcddEe \times AabbCcDdEe$

(1) $Aa \times Aa$

AA Aa Aa (aa)

$$Aa = \frac{1}{4}$$

(2)

$Bb \times bb$
Bb Bb (bb) bb

$$bb = \frac{2}{4}$$

(3)

$Cc \times Cc$
CC Cc Cc (cc)

$$cc = \frac{1}{4}$$

(4)

$dd \times Dd$
Dd (dd) Dd (dd)

$$dd = \frac{2}{4}$$

(5)

$Ee \times Ee$
EE Ee Ee (ee)

$$ee = \frac{1}{4}$$

$$\therefore \frac{1}{4} \times \frac{1}{2} \times \frac{1}{4} \times \frac{1}{2} \times \frac{1}{4} = \frac{2}{1024} \Rightarrow \frac{1}{256}$$

3. 3

Sol. Sexual reproduction leads maximum variation in DNA sequence through generation.

4. 2

Sol. M = 1 mg, → Grass hopper

N = 0.2 mg, → Grass

O = 3mg → Adipose tissues of birds

MNO

Grasshopper, Grass, adipose tissue of bird

5. 4

Sol. Pyramid of energy for every ecosystem is upright.

6. 4

Sol. Human arm, seal forelimb and wings of a bird are homologous organs and they show divergent evolution.

7. 1
Sol. Farmer B performed the practice of mixed cropping. Mixed cropping reduces risk and gives some insurance against failure of one of the crops.

8. 3
Sol. Egg shell is made up of calcium carbonate when it kept in HCl it reacts with CaCO_3 and dissolves the shell.

9. 1
Sol. Iodine helps to produce thyroxine, which is important for metamorphosis.

10. 1
Sol.

Test tube – A	Test tube – B	Test tube – C
Saliva + Iodine ↓ incubation	Starch + Saliva ↓ incubation	Starch + Saliva + Enzyme Inhibitor ↓ Incubation + Iodine
Yellow colour	No colour	Blue black colour

* iodine is camel brown in colour

* When iodine reacts with starch gives blue black colour

11. 2
Sol. Test tube A – Mitochondria
Test tube B – Rough Endoplasmic Reticulum (RER)
Test tube C – Lysosome

12. 1
Sol.

Column 1		Column 2	
A.	Ovary	I.	Progesterone
B.	Pancreas	II.	Insulin
C.	Adrenal gland	VIII.	Aldosterone
D.	Parathyroid	III.	Parathyroid hormone
E.	Pituitary gland	V.	Follicle stimulating hormone

13. 2
Sol. Antibiotics helped in the selection for bacterium with mutations in the DNA conferring drug resistance which were already present in the population.

CHEMISTRY

14. 4

Sol. Number of moles of glucose = $\frac{1.80}{180} = 10^{-2}$ moles

Number of molecules of glucose = $10^{-2} \times 6.022 \times 10^{23} = 6.022 \times 10^{21}$ molecules of glucose
 Total number of O – atom present in glucose = $6 \times 6.022 \times 10^{21}$

Number of moles of water = $\frac{36}{18} = 2$ moles

Number of H₂O molecule = $2 \times 6.022 \times 10^{23}$ molecule

∴ No. of O atom in water = 12.044×10^{23}

Total number of O – atom present in solution = $12.044 \times 10^{23} + 36.138 \times 10^{21}$
 = 12.40×10^{23} oxygen atom

15. 3

Sol. F, Cl, N & O are electronegative element. In second period of periodic table the tendency of forming anion increase upto fluorine.

16. 1

Sol. Rate of evaporation \propto Temperature & wind speed

Rate of evaporation $\propto \frac{1}{\text{Humidity}}$

17. 2



0.1 M 0.04 M

0.01 mole 0.004 mol

Mole of NaOH left = 0.006

∴ Amount of NaOH = $0.006 \times 40 = 0.24$

18. 1

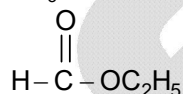
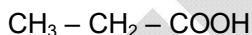

19. 1

Sol. Average atomic mass = $\frac{\sum (\% \text{ Abundance} \times \text{Isotopic mass})}{100}$

20. 2

Sol. In detergent, hydrophobic part bend with hydrocarbon part and hydrophilic part

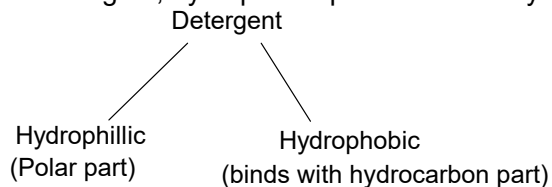

21. 2
Sol.

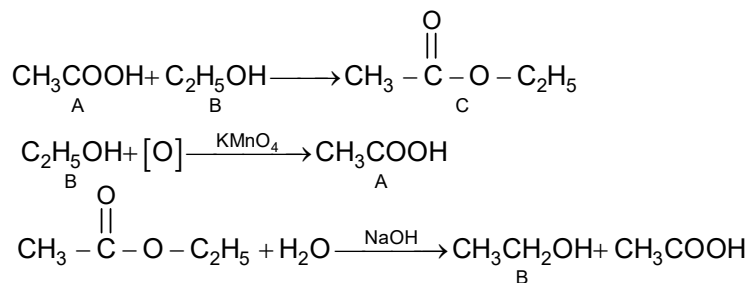

22. 1

Sol. The solution of NaOH + CH_3COOH have pH more than 7.
S.B
W.A

23. 4

Sol. As we go in periodic table from left to right in period, atomic size decrease, so size of B is not smaller than K

24. 4

Sol. When current is applied to electrochemical cell Cu(II) was in solution and reduced to Cu -atom at the cathode Cu -atom on the anode are oxidized in Cu(II) ions. The cathode gain mass, the anode loses mass

25. 1

Sol. The order of reactivity of metal is
 $Z > \text{Zn} > \text{Fe} > \text{Y} > \text{Cu} > \text{X}$

26. 3

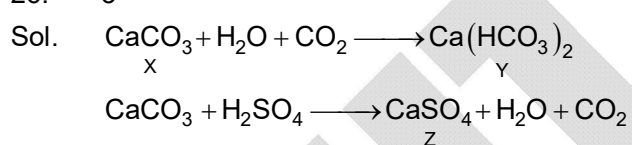

PHYSICS

27. 4
Sol.

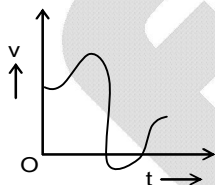

28. 4

Sol. Loss of PE = Gain in K.E.

$$\Rightarrow v = \sqrt{2gh}$$

$$\therefore \frac{v_A}{v_B} = \sqrt{\frac{h_A}{h_B}} = \sqrt{\frac{18}{8}} = \frac{3}{2}$$

29. 3

Sol. When two bodies of equal masses undergo elastic collision in one dimension, their velocities gets interchanged.

30. 3

Sol. Buoyant force = Weight of body (flotation)

$$V \times \rho_l \times g = M_b \times g$$

$$V \times \rho_l = M_b$$

Fraction remains same.

31. 2

Sol. Given, $mg_1 = 0.25 mg$

$$g_1 = \frac{g}{4}$$

$$\& \quad T = 2\pi\sqrt{\frac{L}{g}}$$

32. 3

Sol. $KE = PE = \frac{KE_{\max}}{2}$

$$\frac{1}{2}mv_1^2 = \frac{1}{2}mu^2$$

$$v_1 = \frac{u}{\sqrt{2}}$$

$$t_1 = \frac{u}{\sqrt{2}g}$$

Body will reach back to point A from maximum height in time t_1 .

$$\text{Total time interval} = 2t_1 = 2 \times \frac{u}{g} = \sqrt{2} \frac{u}{g}$$

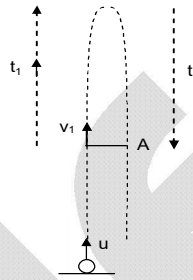

33. 3

Sol. $\frac{1}{2}mv^2 + mgx = \frac{1}{2}kx^2$

$$\frac{1}{2} \times 10 \times (10)^2 + 10 \times 10 \times \frac{5}{100} = \frac{1}{2} \times k \times \left(\frac{5}{100}\right)^2$$

$$k = 4 \times 10^5 \text{ N/m}$$

34. 1

Sol. Sound will be produced when ball hit ground

Time taken by ball to return is

$$t_A = \frac{u}{g} = \frac{20}{10} = 2\text{s}$$

$$\text{Distance of cliff } d = \frac{v \times t}{2} = 350 \text{ m.}$$

35. 2

Sol. By sign conversion, for convex mirror

$$v = +ve \quad u = -ve \quad f = +ve$$

$$\frac{1}{f} = \frac{1}{v} = \frac{1}{u}$$

$$\frac{1}{v} = \frac{1}{u} + \frac{1}{f}$$

$$y = mx + c$$

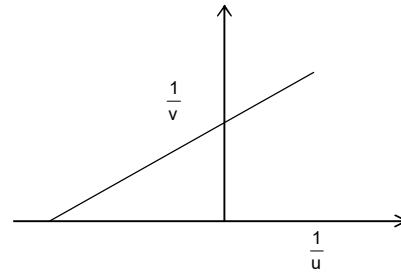

36. 1

Sol.

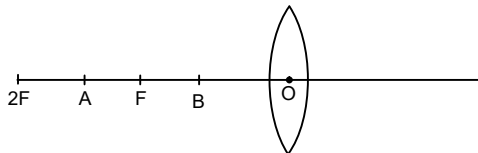

$$m = \frac{f}{f + u}$$

$$\text{For } u = -AO$$

$$U = -BO$$

$$m = -ve$$

$$m = +ve$$

$$-m = \frac{f}{f - AO} \quad \& \quad m = \frac{f}{f - BO}$$

$$\frac{f}{f - AO} = -\frac{f}{f - BO}$$

$$f - BO = AO - f$$

$$2f = AO + BO$$

$$2f = (AF + OF) + (OF - BF)$$

$$2f = 2f + AF - BF$$

$$\Rightarrow AF = BF$$

37. 4

Sol.

I. She suffers from myopia where the far point is nearer than the blackboard.

II. A concave lens with a suitable power can help correct her vision.

III. Her eye is defective and is forming images in front of the retina.

Statements I, II & III are correct.

38. 3

Sol.

For I_{\max}

R_{eq} should be minimum ($V = IR$)

To get minimum resistance least value resistor should be connected in series.

39. 4

Sol.

$$I_{\text{Bulb}} = \frac{110}{220} \text{ A} \quad I_{\text{fan}} = \frac{70}{220} \text{ A} \quad I_{\text{Heater}} = \frac{1200}{220} \text{ A}$$

$$I_{\text{fuse}} = I_{\text{Bulb}} + I_{\text{fan}} + I_{\text{Heater}}$$

$$= 6.27 \text{ A}$$

Fuse wire should be 10 A.

40. 2

Sol.

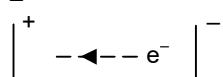

When observed from -ve plate current is towards observer. Thus by RHTR magnetic field is anti-clockwise.

MATHEMATICS

41. 3

Sol. $x = \frac{\sqrt{5} - \sqrt{2}}{2\sqrt{3 + \sqrt{5}} - \sqrt{2}}$
 $\Rightarrow x = \frac{\sqrt{5} - \sqrt{2}}{2\left(\frac{\sqrt{5} + 1}{\sqrt{2}}\right) - \sqrt{2}}$ (Since $\sqrt{3 + \sqrt{5}} = \frac{\sqrt{5} + 1}{\sqrt{2}}$)
 $\Rightarrow x = \frac{\sqrt{5} - \sqrt{2}}{\sqrt{10}} \Rightarrow x\sqrt{10} = \sqrt{5} - \sqrt{2}$
 So, $\frac{x\sqrt{10} + \sqrt{2}}{x\sqrt{10} + 2\sqrt{5}} = \frac{\sqrt{5}}{3\sqrt{5} - \sqrt{2}} = \frac{15 + \sqrt{10}}{43}$

42. 1

Sol. $x = 17q_1 + 9 = 11q_1 + 6q_1 + 9$
 $x - 9$ must be divisible by 11
 $\Rightarrow 11q_1 + 6q_1 + 9 - 9$ is divisible by 11
 $\Rightarrow 6q_1 + 9$ is divisible by 11
 $\Rightarrow q_1 = 10, 21, 32, \dots$
 For $q_1 = 21$, x lies between 300 and 400
 So, $x = 17 \times 21 + 9$
 $= 366$
 Remainder where 366 is divided by 21 is 9.

43. 4

Sol. By long division
 $(ax + b)(x^5 + 1) - (5x + 1) = (x^2 + 1)(ax^4 + bx^3 - ax^2 - bx + a)$
 $+ (a + b - 5)x + (b - a - 1)$
 Taking remainder = 0
 We get $a + b = 5$ and $-a + b = 1$
 On solving we get $a = 2$, $b = 3$
 So, $2a + 3b = 13$

44. 1

Sol. Intersection point of $15x + 20y = -2$ and $x - y = -2$ is $x = \frac{-6}{5}$, $y = \frac{4}{5}$
 Now $2\left(-\frac{6}{5}\right) + 3\left(\frac{4}{5}\right) = k^2$
 $\Rightarrow k^2 = 0 \Rightarrow k = 0$
 So, k is an integer

45. 3

Sol. $(a_{13} - a_3)^2 = a_{13}^2 + a_3^2 - 2a_{13}a_3$
 $\Rightarrow (10d)^2 = 5 - 2a_{13}a_3$

$$\Rightarrow d^2 = \frac{5 - 2a_{13}a_3}{100}$$

$$\text{Now } a_4 \times a_{12} = (a_3 + d) \times (a_{13} - d)$$

$$\Rightarrow R = a_3a_{13} + d(a_{13} - a_3) - d^2$$

$$\Rightarrow R = a_3a_{13} + 9d^2$$

$$\Rightarrow R = a_3a_{13} + 9 \left[\frac{5 - 2a_{13}a_3}{100} \right]$$

$$\Rightarrow a_{13}a_3 = \frac{100R - 45}{82}$$

46. 2

Sol. α, β are roots of $2x^2 - 5x - 6 = 0$

$$\Rightarrow 2\alpha^2 - 5\alpha - 6 = 0 \Rightarrow \alpha^2 - 3 = \frac{5\alpha}{2}$$

$$\text{Similarly, } \beta^2 - 3 = \frac{5\beta}{2}$$

$$\text{Now, } \frac{P_9 - 3P_7}{4P_8} = \frac{(\alpha^8 - \beta^8) - 3(\alpha^6 - \beta^6)}{4(\alpha^7 - \beta^7)}$$

$$= \frac{\alpha^6(\alpha^2 - 3) - \beta^6(\beta^2 - 3)}{4(\alpha^7 - \beta^7)}$$

$$= \frac{\frac{5}{2}[\alpha^7 - \beta^7]}{4[\alpha^7 - \beta^7]} = \frac{5}{8}$$

47. 2

Sol. Total numbers = 1000

Now numbers of form m^n are either perfect square or perfect cube or of form m^5 or m^7

Now, for $n = 2$, m can take 30 values

for $n = 3$, m can take 7 values (excluding 64 and 729 as these are counted in perfect square)

for $n = 5$, m can take 2 values

for $n = 7$, m can take 1 value

$$\begin{array}{r} \text{Total} \\ \hline 40 \end{array}$$

$$\text{Probability} = \frac{40}{1000} = \frac{1}{25}$$

48. 3

Sol. A (-5, 5), B (4, -5), C (4, 5)

By distance formula

$$AB = \sqrt{181}$$

$$BC = 10$$

$$AC = 9$$

$$\text{Since } AB^2 = BC^2 + AC^2$$

$$\Rightarrow \text{ABC is right angled triangle and } \angle C = 90^\circ, \text{ hypotenuse} = \sqrt{181}$$

$$\text{Radius of circum circle} = \frac{\sqrt{181}}{2}$$

So, required area

$$= \pi \left(\frac{\sqrt{181}}{2} \right)^2 - \frac{1}{2} \times 10 \times 9$$

$$= \frac{181}{4} \pi - 45$$

49. 2

Sol. B' (-3, 1) is image of B (3, 1) in y-axis

Now $\triangle CB'D \cong \triangle CBD$

$\Rightarrow CB = CB'$ (CPCT)

Since $CB + CA$ is minimum

$\Rightarrow CB' + CA$ is also minimum which is possible when B', C and A are collinear

\Rightarrow Slope of B' C = Slope of AB'

$$\Rightarrow \frac{k-1}{3} = \frac{3}{10} \Rightarrow k = \frac{19}{10}$$

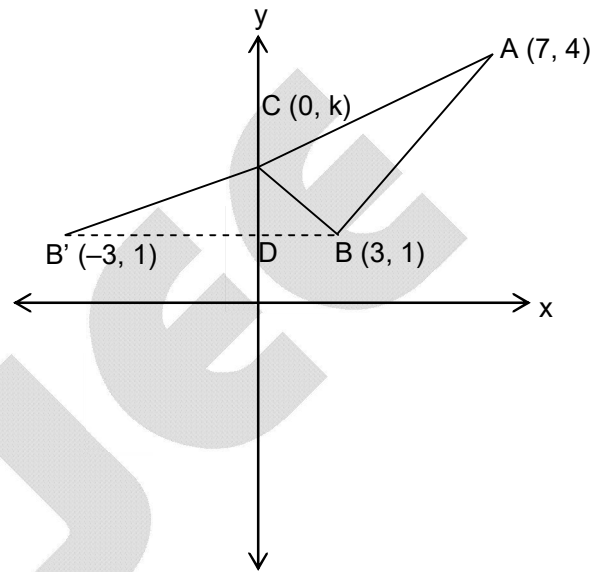

50. 2

Sol. $\triangle OQA \sim \triangle OAP$

$$\Rightarrow \frac{OQ}{OA} = \frac{OA}{OP} \Rightarrow OA^2 = OQ \times OP$$

$$\Rightarrow r^2 = OQ \times OP$$

51. 4

Sol. $\triangle PXQ \sim \triangle CXB$

$$\therefore \frac{XM}{XN} = \frac{PQ}{BC} = \frac{1}{4}$$

$$XM + XN = 9$$

$$\Rightarrow 5 \times XM = 9$$

$$\Rightarrow XM = \frac{9}{5} \text{ cm}$$

$$\text{area } (\triangle PXQ) = \frac{1}{2} \times PQ \times XM$$

$$= \frac{1}{2} \times 2 \times \frac{9}{5}$$

$$= 1.8 \text{ cm}^2$$

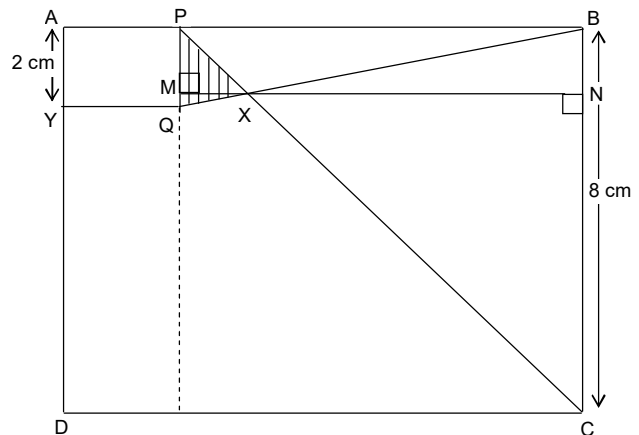

52. 2

Sol. Let $\angle ABC = \angle ACB = \theta$ and $\angle CEF = X$
 then $\angle AFE = \angle AEF = \theta + X$
 Now by exterior angle property
 $\angle AEC = \angle ABE + \angle BAE$
 $\Rightarrow \theta + 2x = 40 + \theta \Rightarrow x = 20^\circ$

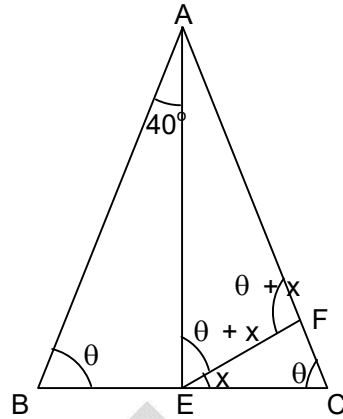

53. 4

Sol. $AF = 6 \Rightarrow AE = 6 \operatorname{cosec} 30^\circ = 12$
 $\Rightarrow AC = 2x - 12$ and
 $\angle CDE = \angle CED \Rightarrow CE = CD$
 $\Rightarrow 2x - 12 = x \Rightarrow x = 12$
 $BF = 2x - 6 = 18$

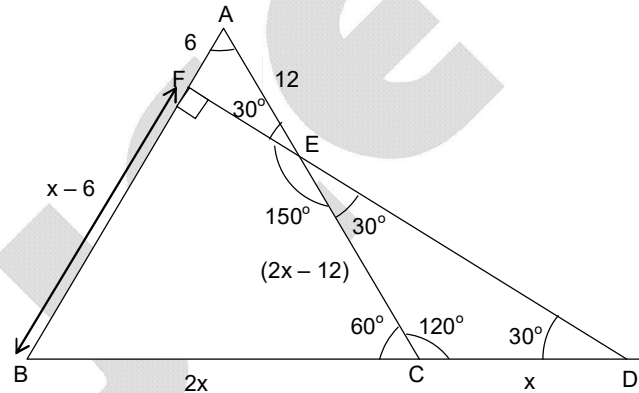

54. **No Option Correct**

Sol. When water level rise 15 cm then radius of top surface of water level = $\frac{20 + 10}{2} = 15$ cm

$$\text{Required time} = \frac{\frac{1}{3} \pi [15^2 + 10^2 + 15 \times 10] \times 15}{\pi \times 5 \times 5 \times 10}$$

= 9.5 minutes

55. 2

Sol. $S = 6$

$$\Delta = \sqrt{6 \times (1)(6-a)(a-1)}$$

$$= \sqrt{6(6a + a - a^2 - 6)}$$

$$= \sqrt{-6a^2 + 42a - 36}$$

$$\Delta_{\max}^2 = \frac{-D}{4a}$$

$$= \frac{75}{2}$$

$$\Delta_{\max} = \sqrt{\frac{75}{2}}$$

$$= 5 \frac{\sqrt{3}}{\sqrt{2}}$$

$$= \frac{5}{2} \sqrt{6}$$

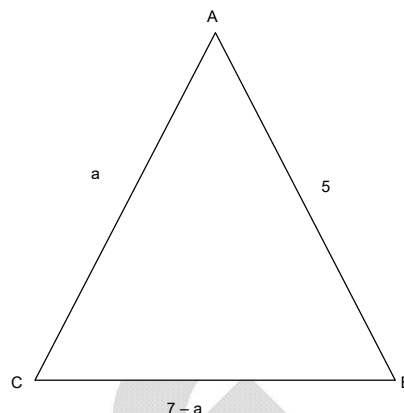

56. 1

Sol. $u = \cos \theta \left(\sin \theta + \sqrt{\sin^2 \theta + \sin^2 \alpha} \right) \quad u \in \mathbb{R}$

$$u \sec \theta = \sin \theta + \sqrt{\sin^2 \theta + \sin^2 \alpha}$$

$$(u \sec \theta - \sin \theta)^2 = \sin^2 \theta + \sin^2 \alpha$$

$$u^2 \sec^2 \theta - 2u \tan \theta = \sin^2 \alpha$$

$$u^2 \tan^2 \theta - 2u \tan \theta + u^2 - \sin^2 \alpha = 0$$

$$\tan \theta \in \mathbb{R}, D \geq 0$$

$$4u^2 - 4(u^2)(u^2 - \sin^2 \alpha) \geq 0$$

$$4u^2(1 - u^2 + \sin^2 \alpha) \geq 0$$

$$u^2 \leq 1 + \sin^2 \alpha$$

$$-\sqrt{1 + \sin^2 \alpha} \leq u \leq \sqrt{1 + \sin^2 \alpha}$$

57. 1

Sol. Let PQ be the tower.

$$\tan 45 = \frac{PQ}{AQ}$$

$$\Rightarrow PQ = AQ = x \text{ (say)}$$

$$\tan 30 \Rightarrow \frac{PQ}{BQ} = \frac{1}{\sqrt{3}}$$

$$\Rightarrow BQ = \sqrt{3}x$$

$$\text{Now, } OA^2 + AQ^2 = BQ^2 + DB^2$$

$$a^2 + x^2 = 3x^2 + b^2$$

$$2x^2 = a^2 - b^2$$

$$x^2 = \frac{a^2 - b^2}{2}$$

$$PQ^2 = x^2 = \frac{a^2 - b^2}{2}$$

$$PQ = \sqrt{\frac{a^2 - b^2}{2}}$$

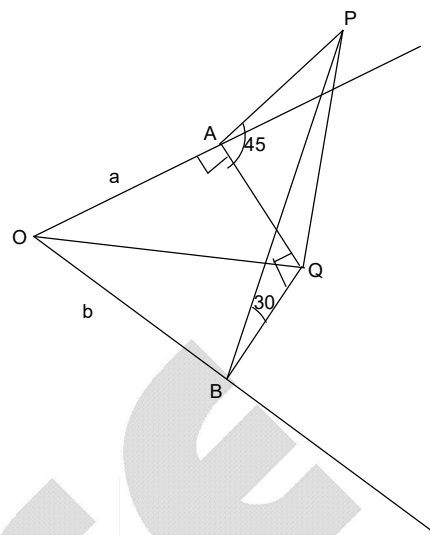

58. 1

Sol. $PB = \sqrt{4^2 + 8^2} = \sqrt{80} = 4\sqrt{5} \text{ cm}$

$$\text{ar}(\triangle PCB) = \frac{1}{2} \text{ar}(\square ABCD)$$

$$= \frac{1}{2} \times 64 = 32 \text{ sq. cm}$$

$$\therefore \frac{1}{2} \times PB \times CE = 32$$

$$\frac{1}{2} \times 4\sqrt{5} \times CE = 32$$

$$CE = \frac{16}{\sqrt{5}}$$

Also, $\triangle PAB \sim \triangle BEC$

$$\Rightarrow \frac{PA}{BE} = \frac{AB}{EC} = \frac{PB}{BC}$$

$$\Rightarrow \frac{4}{BE} = \frac{8 \times \sqrt{5}}{16} = \frac{4\sqrt{5}}{8}$$

$$\Rightarrow BE = \frac{8}{\sqrt{5}}$$

$$\therefore \text{ar}(\triangle BEC) = \frac{1}{2} \times CE \times BE$$

$$= \frac{1}{2} \times \frac{16}{\sqrt{5}} \times \frac{8}{\sqrt{5}}$$

$$= \frac{64}{5} \text{ cm}^2$$

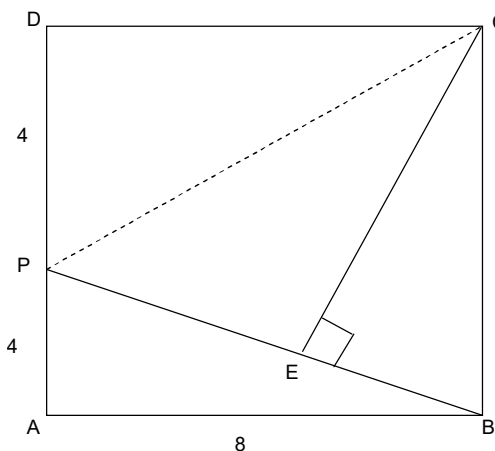

59. 2

Sol. Let numbers are a, b and c

a is smallest and c is largest then median = 5 $\Rightarrow b = 5$

$$\text{also, } \frac{a+b+c}{3} = a+10 = c-15$$

$$\Rightarrow a = 0 \text{ and } c = 25$$

$$\text{So, } a^2 + b^2 + c^2 = 650$$

60. 4

Sol. Let radius of sphere A is a

radius of sphere B is b

$$\text{then } 4\pi b^2 = 4\pi a^2 + 8 \times 4\pi a^2$$

$$\Rightarrow \frac{a}{b} = \frac{1}{3} = \frac{k}{3k} \text{ (let)}$$

$$V_B - V_A = \frac{4}{3}\pi[(3k)^3 - (k)^3] = \frac{4}{3}\pi(26k^3)$$

$$\begin{aligned} \text{Required percentage} &= \frac{\frac{4}{3}\pi(26k^3)}{\frac{4}{3}\pi(3k)^3} \times 100 \\ &= 96.3\% \text{ (Approx)} \end{aligned}$$